

NOTES:

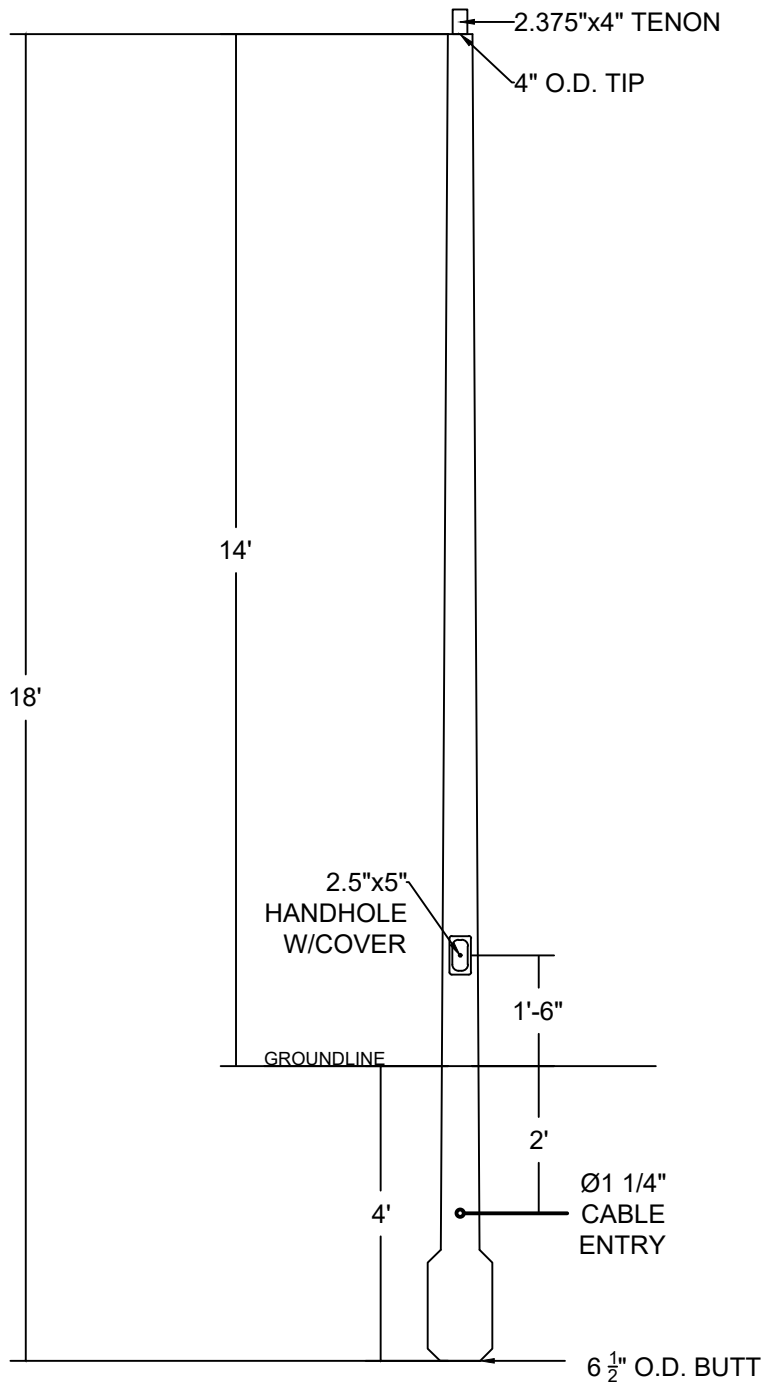

FILAMENT WOUND SECTIONAL COMPOSITE SHAFT CONSISTING OF CONTINUOUS FIBERGLASS ROVING COMBINED WITH THERMOSETTING POLYESTER RESIN WOUND IN LOW ANGLE HELIACAL AND HIGH ANGLE HOOPS PROVIDING FOR MAXIMUM RESISTANCE TO DEFLECTION AND SHEAR. POLE FINISH IS A 10-15 ML THICK POLYESTER FINISHING RESIN. DIRECT BURIAL POLE ASTM 4923 CLASS 1 (POLE TOP DEFLECTION SHALL NOT EXCEED 15% OF THE ABOVE HEIGHT @ MAX WIND LOADING AND MAX FIXTURE WEIGHT) DESIGN CRITERIA PER 2017 FBC 6TH EDITION AND ANSI C136.20-2012

CATALOG# DS18FSDN2

EPA 2.6

COLOR BRONZE

WINDZONE 150 MPH

FINISH NATURAL

BUILD STANDARD